



ALL EASY Pro

1 screw, 1 minute
for simplified installation & maintenance



All Easy Pro

Superior Cooling/Heating Performance and Airflow.
Outstanding Energy Efficiency with A+++ rating on both Cooling & Heating.



1 screw
1 minute



Easy
Installation



Easy
Clean



Energy
Efficiency



Follow
Me



Smart
Kit



Split/Multi-Split
Functions



ALLEASY Pro

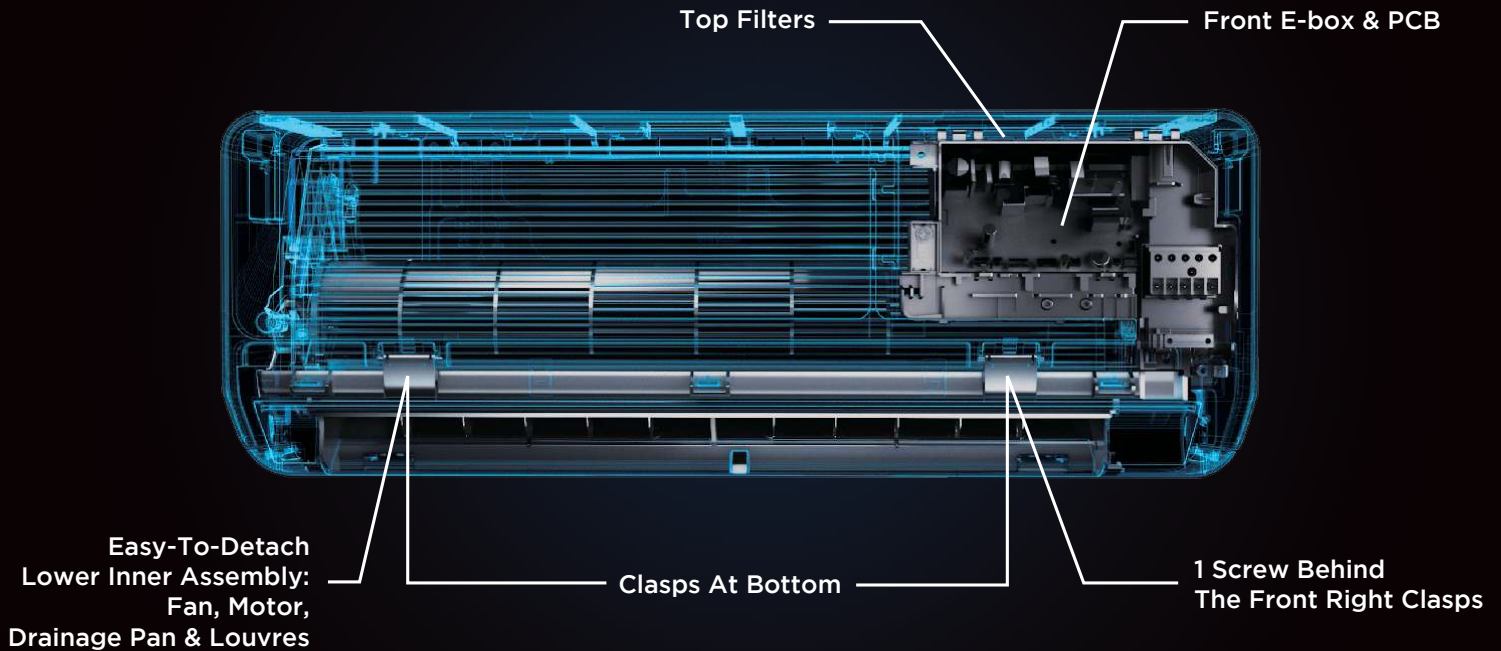

**We Explore The New Possibilities of AC Structure
And So A New Way To Cool Your Home**

All Easy Pro vs. Others

Fast Installation



All Easy Pro: **6 min 47 sec**
Others: **11 min 33 sec**

Fan Motor Assembly



All Easy Pro: **1 min 12 sec**
Others: **17 min 37 sec**

PCB Replacement



Fan Motor: **1 min 12 sec**
Assembly: **21 min 3 sec**

= **1/5** time for 1 AE Pro Maintenance Compare to Regular AC unit

ALL THE INSTALLATION WORKS GET EASY

Easy Measure and Fix Without Extra Tools

Super slim mounting plate with built-in scale and horizontal meter. Measure, mark and fix with just one plate.



STEP 1: Mark the **SPOT A** according to the instruction of scale-on-plate

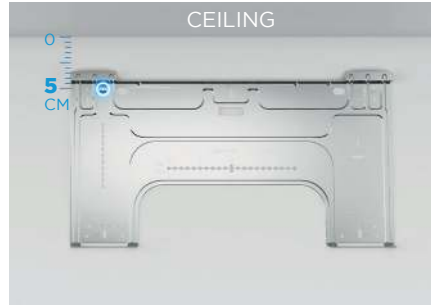

STEP 2: Move down the plate until the punch hole to the **SPOT A**

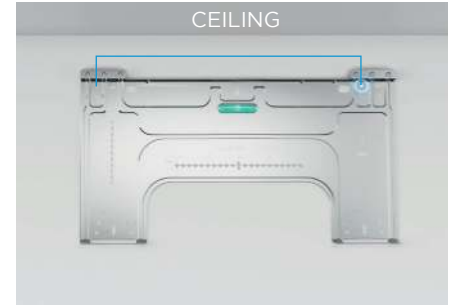

STEP 3: Locate the punch hole on other side with the Horizontal Meter on plate for precise levelling

Easy Wiring In 3 Seconds

176mm large piping space with installation support clip.

Front-placed E-BOX for convenient access wiring just opening the front panel.



Flexible Space Cooling Solution

Max. **15M** Piping Height and **30M** Piping Length. Requires Min. **5CM** Of Ceiling Distance

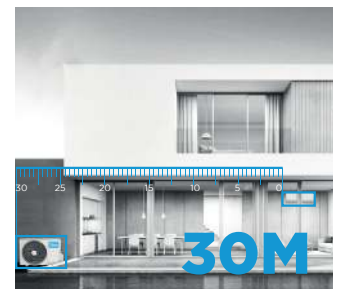

Impeccable Installation Done In 10 Steps

- STEP 1**
Unpack
- STEP 2**
Mark Position With Mounting Plate
- STEP 3**
Punch Position Confirm
- STEP 4**
Fixed The Mounting Plate On Wall
- STEP 5**
Check Backward Piping Hole
- STEP 6**
Hang Up Indoor Unit
- STEP 7**
Piping
- STEP 8**
Connect The Wire
- STEP 9**
Install Drainage Pipe
- STEP 10**
Warp The Pipe & Wire

SAVE ENERGY

Minimal Structure, Minimalize Your Bill

+23.5%

Thanks to the front E-box and PCB design that releases more space for a larger air volume in and out, the AE Pro delivers you the stronger cooling performance with lower monthly energy bills.

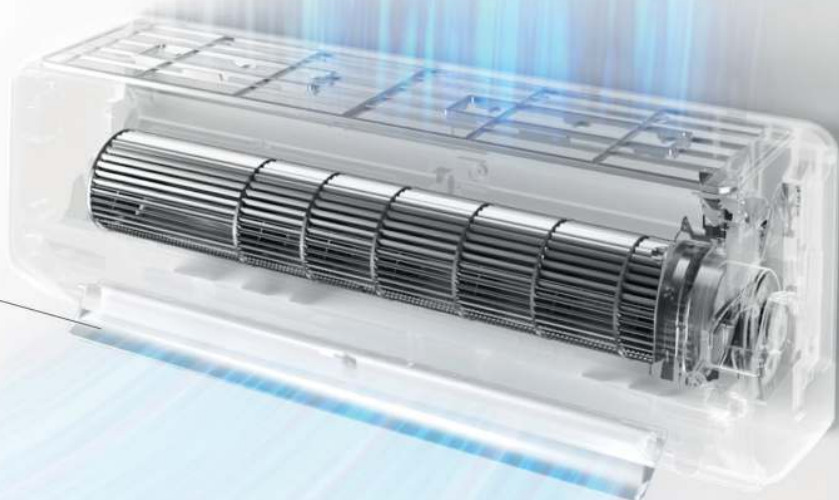

TURBO MODE

Achieve the setting temperature with cool air in maximum speed with just a touch of the Turbo button.

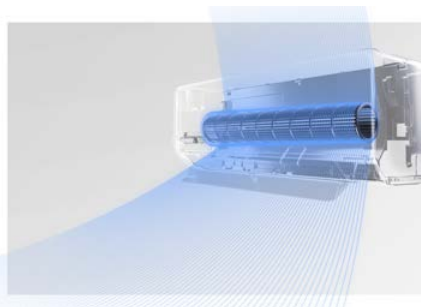

3D AIRFLOW

The deflectors swing automatically in all directions to intentionally direct airflow to every corner of the room.

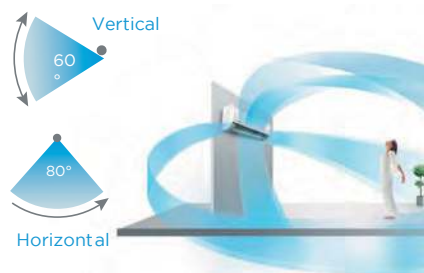

INTELLIGENT EYE

This unique feature automatically activates energy-saving mode or turns the unit off when detecting an empty room, reducing your energy costs by up to 25%.



DURABILITY

Designed with Innovation, Built to Last

Equipped with the best protection against the natural elements, Midea air conditioners are primed and designed to last.



PRIMEGUARD™ GOLDEN FIN

Get more resistance from water, rust, adherent grease, oxidation and other corrosive elements with a steadier cooling performance with our signature Golden Fin protection.

- The Golden Fin coated cover protects the motor and prevents water from seeping into the indoor unit, preventing mould and rust.
- Our signature Golden Fin repels water, making it more durable and less likely to breakdown.

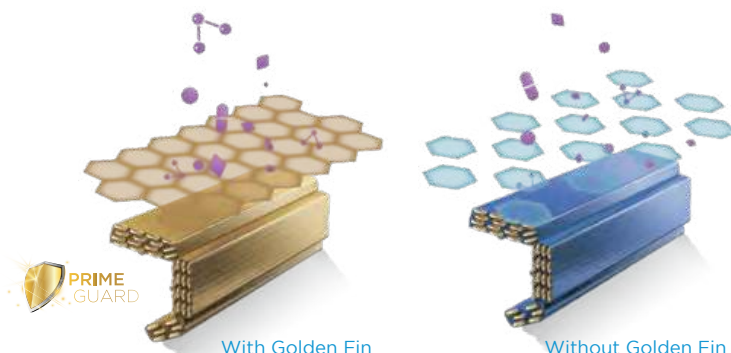



Every breath is protected

There's nothing more important than the health of you and your loved ones. Midea has integrated crucial technology that will produce cleaner and fresher air from its range of air conditioners. With an innovative air protection system, say goodbye to dust, bacteria and unpleasant odours from the air you breathe; it's all efficiently taken care of to protect everyone at home.

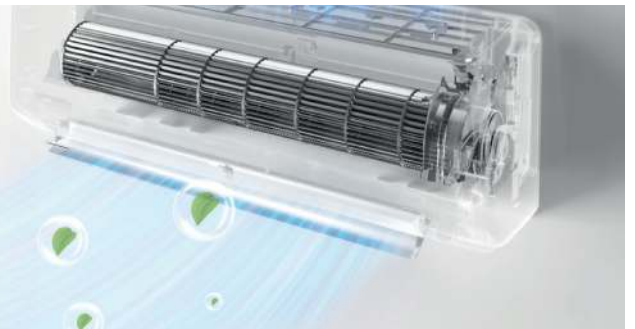

DUAL FILTRATION

The Dual Filtration system thoroughly eliminates harmful substances to provide you with fresh and clean air.

STEP 1:

Full High Density (HD) Filter

Blocks out dust particles and other airborne impurities as an initial screening.



Dog hair



Dead mite feces



Fungi



Flower pollen



Bacteria



Smoke



STEP 2:

Activate Carbon Filter with Vitamin C Filter Cover

This forms positive positions on the filter surface and traps small dust particles, smoke and pet fur to prevent allergies. The Vitamin C filter releases particles in the air to help rejuvenate your skin.



MOISTURISING SKIN

A 3-in-1 filter designed with a special vitamin C component helps soften and moisturise your skin.



ANTI-MOULD SELF-CLEANING

Our self-sustaining indoor units has a cooling coil that cleverly switches to dry operation and runs at a very low speed for 15 to 20 minutes. This eradicates any growth of mould or bacteria and also helps to extend the life of the air conditioner.



DEEPER ACCESS

The remarkable detachable fan wheel design increases access for deep cleaning by up to 50% and can be easily disassembled in just 1 minute to thoroughly clean the fan and heat exchanger.

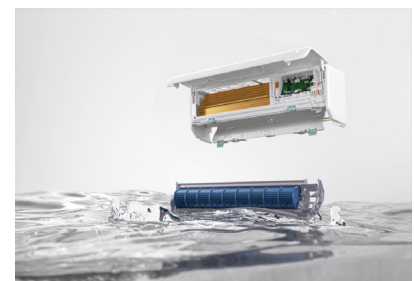

COMFORT

Your comfort comes first

Apart from the innovative technology that drives Midea air conditioners to be the best, we strive to always produce a product that has the comfort of its users as a top priority. Key comfort features in our air conditioners maintain temperatures, keep you cool on the move and is quietly calming for the ideal environment in your home or office.



“FOLLOW ME”

Keep your remote close to you and let the “Follow Me” mode measure the air temperature around you. This allows for cool air to be delivered directly to your position in an effortless way.

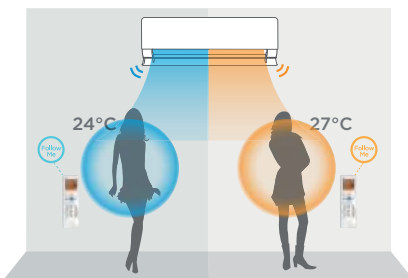

ON UNIT LED DISPLAY

The LED display illuminates at the center of the unit so you'll always know what temperature is set.



QUIETER OPERATION

Operating as quiet as 21dB allows you to rest peacefully and maintains a calm ambience in your spaces. The only sound that's heard, is the cool air circulating the room.

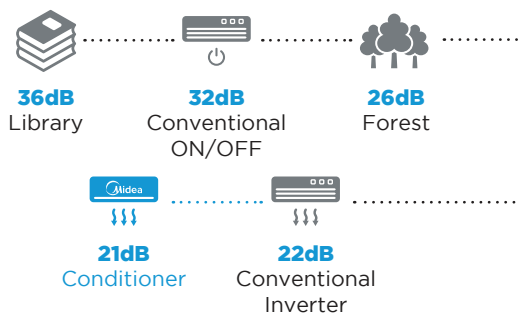

SLEEP MODE

Keeping with the theme of ultimate comfort, sleep mode adjusts the room temperature after you've fallen asleep to make sure you're not too cold. By doing this, it also saves energy.



INTELLIGENTIZE In Built Innovation



Control Your AC, Anytime and Anywhere WIFI Control

Wherever you are, you can keep your home comfortable using the Midea SmartHome App.

Start up your air conditioner on the way home to enjoy crisp, cool air the moment you walk in the door. The possibilities for comfort and convenience are endless.

Technical Data

Internal Unit Code			MSEPBU-09HRFN8	MSEPBU-12HRFN8	MSEPCU-18HRFN8	MSEPDU-24HRFN8
External Unit Code			MOX330-09HFN8	MOX330-12HFN8	MOX430-18HFN8	MOX430-24HFN8
Maximum Cooling Capacity			13,000 Btu	14,510 Btu	21,000 Btu	29,000 Btu
Maximum Heating Capacity			15,000 Btu	15,500 Btu	23,100 Btu	32,415 Btu
Power Supply			F-V-Hz		Monofase 220-240V 50Hz	
Cooling	Cooling Capacity	kW (Min-Nom-Max)	1,31-2,73-3,81	1,31-3,52-3,96	3,75-5,57-6,13	2,11-7,03-8,21
	Absorbed Power	W (Min-Nom-Max)	130-600-1200	130-880-1250	587-1318-1787	420-1760-3200
	Current	A (Nom)	2,6	3,8	5,7	7,7
	Theoretical Load (PdesignC)	kW	2,6	3,5	5,3	7,0
	SEER		8,6	8,5	8,5	8,5
	Energy Efficiency Rating		A+++	A+++	A+++	A+++
	Annual Energy Consumption	kWh/A	106	144	220	288
Heating	Heating Capacity	kW (Min-Nom-Max)	0,88-3,14-4,40	0,88-3,96-4,54	2,57-5,57-6,77	1,55-7,33-9,21
	Absorbed Power	W (Min-Nom-Max)	120-690-1400	120-990-1450	943-1500-1695	300-1975-3100
	Current	A (Nom)	3,0	4,3	6,5	8,7
	Theoretical Load (PdesignH)	kW	2,5	2,5	4,3	5,5
	SCOP		5,1	5,1	5,4	5,3
	Energy Efficiency Rating		A+++	A+++	A+++	A+++
	Annual Energy Consumption	kWh/A	686	686	1400	1666
Energy Efficiency	Temperature Operating Limit (ToI)	°C	-15	-15	-15	-15
	E.E.R./C.O.P.	W/W	4,54/4,55	4,00/4,00	4,22/3,71	4,00/3,71
Indoor Unit	Dimensions (W-D-H)	mm	795-225-295	795-225-295	965-239-319	1140-275-370
	Net Weight	Kg	10,2	10,2	12,3	20,0
	Packaging dimensions (W-D-H)	mm	870-370-305	870-370-305	1045-400-325	1230-355-455
	Gross Weight	Kg	13,0	13,0	16,4	25,3
	Air Flow (Min-Med-Max)	m³/h	280-360-530	290-380-560	400-580-685	379-724-1092
	Sound Pressure (Min-Med-Max)	dB(A)	21,5-32-39	22-33-40	23-35-41	33-40-44,5
	Sound Power (Min-Med-Max)	dB(A)	58	59	59	65
Outdoor Unit	Dimensions (W-D-H)	mm	805-330-554	805-330-554	890-342-673	890-342-673
	Net Weight	Kg	28,4	28,4	38,8	45,6
	Packaging dimensions (W-D-H)	mm	915-370-615	915-370-615	995-398-740	995-398-740
	Gross Weight	Kg	31,0	31,0	41,9	48,8
	Air Flow	m³/h	2200	2200	3500	3500
	Sound Pressure (Max)	dB(A)	57	57,5	56	58,5
	Sound Power (Max)	dB(A)	64	65	65	68
Refrigerant Circuit	Compressor Type		ROTARY	ROTARY	ROTARY	ROTARY
	Piping Connection - Liquid	mm	6,35	6,35	6,35	9,52
	Piping Connection Gas	mm	9,52	9,52	12,7	15,88
	Pre-Charged Pipe Length	m	5	5	5	5
	Maximum Pipe Length	m	25	25	30	50
	Additional Refrigerant Charge	g/m	12	12	12	24
	Maximum Level Difference	m	10	10	20	25
Refrigerant	Refrigerant Type		R32	R32	R32	R32
	GWP		675	675	675	675
	Refrigerant Charge	Kg	0,69	0,69	1,10	1,50
	Emmissions CO ₂	Ton	0,466	0,466	0,743	1,013
	Test Pressure (High Side/ Low Side)	MPa	4,3/1,7	4,3/1,7	4,3/1,7	4,3/1,7
Electrical Characteristics	Main Power Supply		External Unit	External Unit	External Unit	External Unit
	Indoor-Outdoor Unit Connection	n° Conductors	4P + Earth	4P + Earth	4P + Earth	4P + Earth
	Maximum Absorbed Power	W	2300	2300	2800	3700
	Maximum Current	A	10,0	10,0	12,2	16,8
Operation Temperature	Indoor Temperature	Cool. (Min-Max) °C B.U.	+16 - +32	+16 - +32	+16 - +32	+16 - +32
		Heat. (Min-Max) °C B.S.	0 - +30	0 - +30	0 - +30	0 - +30
	Outdoor Temperature	Cool. (Min-Max) °C B.S.	-15 - +50	-15 - +50	-15 - +50	-15 - +50
		Heat. (Min-Max) °C B.U.	-20 - +24	-20 - +24	-20 - +24	-20 - +24

